



Collection landscaping in the common information environment: a case study using the Scottish Collections Network (SCONE)

Report for Work Package B of the JISC CC-interop project

**Written by: Gordon Dunsire
Published by: Centre for Digital Library Research
University of Strathclyde
Glasgow
June 2004**

Contents

Executive Summary.....	3
Screens, diagrams and tables.....	5
Introduction: JISC Information Environment and CAIRNS.....	6
Static Clumps.....	9
Dynamic Clumps.....	14
Relating SCONE/CAIRNS to other landscapes	40
Implications for UKNUC.....	44
Conclusion	47
References	49

Executive summary

Collection-level description has a role to play in all stages of the Information Environment:

- The Entry stage can be a set of all CLDs in a service, or some pre-selected sub-set.
- The Survey stage involves refining the set presented in the Entry stage, by finding CLDs with related characteristics.
- The Discovery stage can use hyperlinks to online finding aids from individual CLDs. The set of CLDs selected in the Survey stage can be used to create sub-sets of catalogues in distributed union catalogues.
- The Detail stage can use collection location and agent information to determine general collection availability.

Collection landscaping services can offer a number of Entry stage modes:

- The set of all collections in the environment.
- A static sub-set of collections designed for frequent use.
- Facilities for dynamic creation of sub-sets by searching for common attributes.
- Facilities for manual creation of sub-sets by selection of individual collections.

Automatic invocation by remote landscaping services of any of these Entry stage modes is desirable. Applications include:

- Distributed, hybrid collections with a specific focus.
- Exhibitions and other temporary events with a specific theme.
- Portals based on subjects, people, and places.

A single CLD can be used as the basis of the Survey stage by finding collections with the same location or associated agent.

The principle of functional granularity can be used to create structured collection hierarchies for linking CLDs with collections of metadata aggregated at a higher level. This can be used to simplify the Discovery stage for the user interested in a specific collection by disclosing only the nearest or most co-extensive online catalogues.

The same hierarchies can be used when there are overlapping aggregations of metadata in a single distributed union catalogue or clump. If a lower-level Z target is temporarily unavailable, the hierarchy can be used to automatically disclose a higher-level target.

The Detail stage benefits from general information about access to collections. Such information includes location opening hours, restrictions on access to specific types of collection, and license conditions. This type of information can be inherited from super-collections that are co-extensive with the location and administrator, using functional granularity to create system-defined CLDs where required. This avoids unnecessary duplication of data entry, storage, and maintenance.

Creating a comprehensive set of CLDs for institutional collections based on organization and agent directories as justification for functional granularity produces a service for supporting the Detail stage which is:

- Maintainable. Directories may be updated at regular intervals, and this activity can be redirected to CLD services.
- Able to display general access conditions for special and named sub-collections as soon as they are added, through inheritance from the collection hierarchy.
- The basis of a geographical landscaping service from location addresses, using a controlled thesaurus of towns, regions, and countries.

Collection landscaping is a useful tool to improve the usability of complex information environments such as a UK National Union Catalogue (UKNUC) created as a cross-searchable distributed union catalogue whose components themselves might be physical, harvested, or distributed union catalogues.

This implies that an efficient and effective landscaping service for such an UKNUC would benefit from co-ordination of CLD creation by UK service providers to ensure interoperability at higher levels of aggregation. This should involve the development of a protocol covering:

- Creation and disclosure of unique identifiers for CLDs.
- Guidance on creating CLDs based on functional granularity requirements.
- Disclosure of local CLD hierarchies to external services.
- Recommended minimum set of finding options for landscape mapping by UKNUC users.
- Guidelines on interoperable content for mapping options, such as subject topic, form of agent name, and geographical location.

There are a number of reasons for planning a distributed UKNUC on a regional basis, with the development of information environments based on distinct geographical areas collectively covering the whole of the UK:

- A number of regional information environments are at a relatively advanced stage of development.
- Data for the basis of regional CLD services are available in the form of institutional and service directories, which are often geographically based.
- The physical location of non-digital collections is an important factor for users creating dynamic landscapes.
- Users do not make distinctions about how a collection is managed or its finding aid constructed. There is demand for services that cover archives, libraries, museums, and digital collections in an integrated way.
- There is a likelihood of overlap in regional cross-domain CLD services of personal and organizational agents as owners, collectors, and subjects. Local authorities have ownership of collections in public archives, libraries, and museums. Collectors often split and donate hybrid collections to local cultural institutions. Local people, companies, societies, and agencies will be the subject of archives, manuscripts, memorabilia, ephemera, and books.
- Local information professionals are better-placed to create and maintain controlled vocabularies for local agents and collection subjects, and often have existing networks and mechanisms for co-ordinating such activity.
- Collections with subjects of regional interest tend to be located within the region, and will be catered for by local CLDs. Where collections are located outside of the region, their remote CLDs may not exist or be accessible via the local subject because the remote service has no functional reason for doing so. A local CLD would probably have to be created anyway.

Screens, diagrams, and tables

	Caption	Page
Screen 1	List of active CAIRNS miniclumps.	
Screen 2	Search input form for the Networked, open-access electronic resources miniclump.	
Screen 3	Portlet options in the demonstrator DNBC service (partial screen).	
Screen 4	Menu of options for finding SCONE collections.	
Screen 5	Clickable map of Scottish local authority regions for generating landscapes based on physical location.	
Screen 6	The landscape of collections with level 3 strength in adult education.	
Screen 7	The landscape of collections with language Scots Gaelic.	
Screen 8	Collection-level description for the Tweedsmuir collection.	
Screen 9	Collection-level description for the Springburn virtual museum.	
Screen 10	Contact details for the National Library of Scotland.	
Screen 11	The landscape of collections located in Edinburgh.	
Screen 12	The landscape of collections associated with John Buchan.	
Screen 13	The landscape of collections associated with Highland Council.	
Screen 14	Dynamic CAIRNS miniclump generated by the landscape of collections located in Edinburgh.	
Screen 15	Collection-level description for the COPAC collection.	
Screen 16	Collection-level description for Edinburgh University Library collection.	
Screen 17	Dynamic CAIRNS miniclump generated by the landscape of collections located in Edinburgh, with Edinburgh University Library inactive.	
Screen 18	Finding aids for the landscape of collections located in Edinburgh: first half of list.	
Screen 19	Finding aids for the landscape of collections located in Edinburgh: second half of list.	
Screen 20	Collection-level description of the MacColl and Seeger collection.	
Diagram 1	Functional granularity, collection hierarchy, and inheritance.	
Diagram 2	COPAC collection hierarchy and inheritance.	
Diagram 3	InforM25 collection hierarchy and inheritance.	
Diagram 4	UKNUC as a hybrid, distributed union catalogue.	
Table 1	Examples of library defined miniclumps in CAIRNS.	
Table 2	Examples of end-user defined miniclumps in CAIRNS.	

Introduction: JISC Information Environment and CAIRNS

This report forms deliverable B9 of Work Package B of the COPAC-clumps continuing interoperability project (CC-interop).

The CC-interop project fits within the JISC Information Environment (IE), particularly the Infrastructure Programme. This includes investigation of Z39.50 and enhances the distributed framework of the IE by aiming to bring together distributed catalogues in a virtual way, in order that richer search and retrieve possibilities are available for users.¹

As part of Work Package B, the project included “looking at the intelligent selection of targets in clumps utilising collection level description based on dynamic landscaping”.

Clumps

“Clump” is a term that refers to an aggregation of catalogues to enable large-scale resource discovery. This allows users to search for resources they want across a number of different catalogues. More specifically, the catalogues are distributed, online, and networked, and current methods of cross-searching them usually involve the Z39.50 protocol.

A clump is therefore a type of distributed union catalogue.

JISC Information Environment

The IE is a set of network or online services that support publishing and use of information and learning resources, aiming to offer the user a more seamless and less complex journey to relevant information and learning resources.²

The journey can be categorised in a number of stages according to the functional model of the IE.³

1. **Entry:** the user is presented with an initial set of collections of resources or “landscape” based on a profile or local defaults.
2. **Survey:** the user modifies the landscape by adding or removing collections of resources from the set.
3. **Discover:** the user searches and retrieves individual resources from the set of collections.
4. **Detail:** the user identifies copies of a resource with particular attributes such as availability.

The last stage, Detail, is not necessary for some tasks such as verifying a citation or compiling a bibliography.

Role of clumps in the information environment

A clump has a primary role in the **Discovery** and **Detail** stages of using the IE.

Discovery involves manual and automated searching and browsing of metadata for the resources within the collections selected in earlier stages.

The Detail stage, if required, involves the identification of specific copies by browsing metadata relating to multiple copies or manifestations.

A clump allows cross-searching of metadata conformant with Z39.50 and held in multiple online catalogues. Searching is carried out using a single interface, which allows browsing of the retrieved metadata.

The Discovery and Detail stages of the area of the environment covered by a clump are made seamless, simplifying tasks for the user by reducing the need to use multiple search interfaces one after the other.

Role of collection-level description in the information environment

The **Entry** and **Survey** stages of the IE involve the description of collections of resources. Information resources of all types are usually managed as collections. Metadata for resources are often presented in sets, such as catalogues, corresponding to the collections. Digital resources will be grouped in sets available from single electronic locations.

The developing field of collection-level description (CLD) therefore has a primary role in these first stages of using the IE.

CLD involves metadata about a collection or set of resources at the aggregate level of the collection; that is, it does not cover individual items. If the metadata is sufficiently structured and uniform in content, it can be used to present a pre-selected set of collections as the Entry stage. The CLD metadata can also be made available to the user for refining the landscape during the Survey stage.

Scoping the definition of “collection” to include sets containing just one information resource allows CLD to be used for all items in an IE, accommodating single digital resources, databanks, and online catalogues in the same framework.

CAIRNS

The Co-operAtive Information Retrieval Network for Scotland (CAIRNS)⁴ is the Scottish clump.

Background

CAIRNS was originally developed in 1998-2000 as part of the Electronic Libraries (eLib) Programme. It has subsequently been maintained and developed as part of the CC-interop project, and the Scottish Portals for Education, Information and Research (SPEIR) project⁵.

CAIRNS includes the Z39.50 catalogues of members of the Scottish Confederation of University and Research Libraries (SCURL)⁶. SCURL encompasses the National Library of Scotland (NLS), the Scottish universities and central institutions, and the two largest public library authorities in Scotland.

CAIRNS allows cross-searching of member catalogues using a set of specified indexes.

The set of indexes is determined by their availability in the individual Z servers. Currently, there is no facility to ignore servers which do not support a specific index, so all servers must support the full set. The set is thus a highest common denominator of all available indexes.

The set comprises indexes for:

- Author keyword.
- General keyword.
- Subject keyword.
- Title.
- International Standard Book Number (ISBN).
- International Standard Serial Number (ISSN).

There is no facility for consolidating multiple server results sets by merging, sorting, and de-duplication; this is planned for a forthcoming software upgrade.

Metadata records in individual results sets are presented in standard short and full display formats.

The scope of CAIRNS is being extended to other public and Further Education libraries as part of the SPEIR project.

Static clumps

A static clump is defined as having the characteristics:

- A sub-set of catalogues available in a clump. The sub-set must contain at least one catalogue, and may include all catalogues.
- Sub-set members are added or removed as part of their membership of the clump as a whole. When a new catalogue joins the clump, it is added to all appropriate static clumps.
- The sub-set has persistence. It is made directly available as part of the clump service.

CAIRNS simple search option

The basic or simple search option of the CAIRNS service allows the user to search all catalogues in the clump. This is an example of a static clump containing all members of the clump.

The catalogues for inclusion in this static clump are identified by searching SCONE CLDs for all collection-descriptions (catalogues) that have CAIRNS Z servers.

The user is not able to remove catalogues from the search, and is not given a list of catalogues being searched until the results screen is displayed. The search is carried out on general keyword indexes.

The CAIRNS simple search is characterised with the IE model as:

- Entry: The complete set of catalogues in the CAIRNS clump.
- Survey: Not available.
- Discover: Identify item metadata by general keyword.
- Detail: CAIRNS standard.

Miniclumps

A miniclump in CAIRNS is defined as a static clump that is created for a specific activity or type of user. A miniclump is usually created:

- When it would be difficult to create the sub-set of catalogues by dynamic selection.
- To save keystrokes in manually selecting the same sub-set many times over.
- To simplify operator workflows and instructions.

A CAIRNS miniclump can also include a default index for searching. This allows, for example, the subject keyword index to be specified when the miniclump is scoped by subject.

Unlike the simple search option, a user can modify a CAIRNS miniclump during the Survey stage. After a miniclump is selected, the user can remove any of the member catalogues in the sub-set and add any CAIRNS catalogues that are not in the sub-set. The user can also change which index is to be searched.

The CAIRNS miniclump search is generally characterised within the IE model as:

- Entry: The set of catalogues in the CAIRNS clump, which meet the miniclump scope.
- Survey: Any CAIRNS catalogues can be added or removed.
- Discover: Identify item metadata in specified index.
- Detail: CAIRNS standard.

CAIRNS uses a control record in the SCONE database to define a miniclump in terms of a title and description, the sub-set of catalogues it contains, and which index is defaulted for searching.

The title and description are free-text, and are used for miniclump identification and selection as shown in Screen 1.

The sub-set of catalogues is defined by their primary keys in the database.

The index is defined by its primary key from the table of CAIRNS indexes.

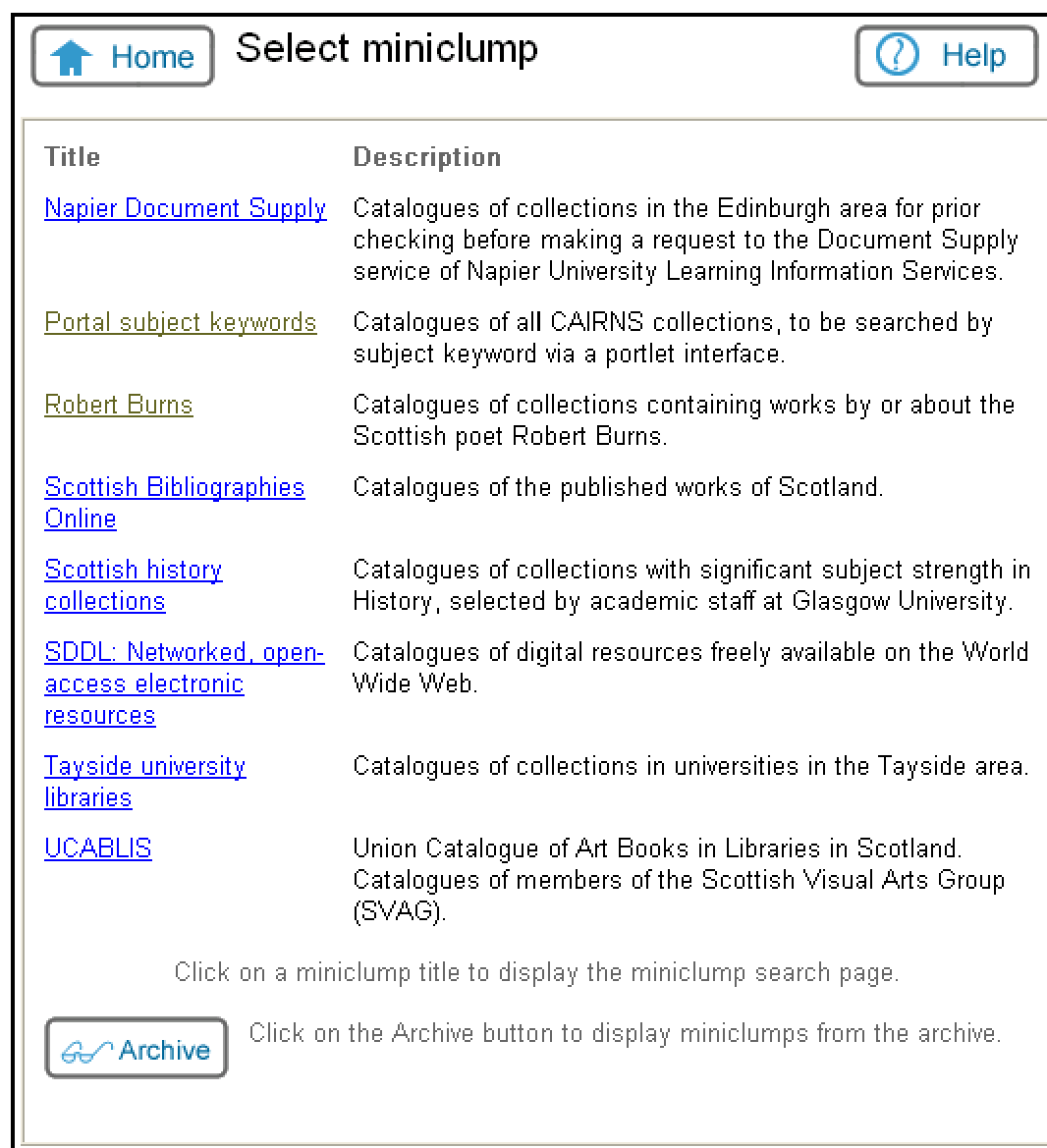

Title	Description
Napier Document Supply	Catalogues of collections in the Edinburgh area for prior checking before making a request to the Document Supply service of Napier University Learning Information Services.
Portal subject keywords	Catalogues of all CAIRNS collections, to be searched by subject keyword via a portlet interface.
Robert Burns	Catalogues of collections containing works by or about the Scottish poet Robert Burns.
Scottish Bibliographies Online	Catalogues of the published works of Scotland.
Scottish history collections	Catalogues of collections with significant subject strength in History, selected by academic staff at Glasgow University.
SDDL: Networked, open-access electronic resources	Catalogues of digital resources freely available on the World Wide Web.
Tayside university libraries	Catalogues of collections in universities in the Tayside area.
UCABLIS	Union Catalogue of Art Books in Libraries in Scotland. Catalogues of members of the Scottish Visual Arts Group (SVAG).

Click on a miniclump title to display the miniclump search page.

 Click on the Archive button to display miniclumps from the archive.

Screen 1: List of active CAIRNS miniclumps (partial screen).

Types of miniclump

CAIRNS has created a number of miniclumps for various purposes during its development. These can be categorized as:

- System defined.
- User defined.

System defined miniclumps

A system-defined miniclump is usually created by the CAIRNS system administrators to improve functionality.

An example is the miniclump titled “Networked, open-access electronic resources”, shown in Screen 2. It only includes those CAIRNS catalogues that are for collections of digital resources which can be accessed freely without authentication.

This miniclump can be selected by users seeking digital resources without retrieving information about print materials. It can also be used as a component of portals and other landscapes which are purely digital, by passing its key identifier in the URL for the portlet application of CAIRNS described below.

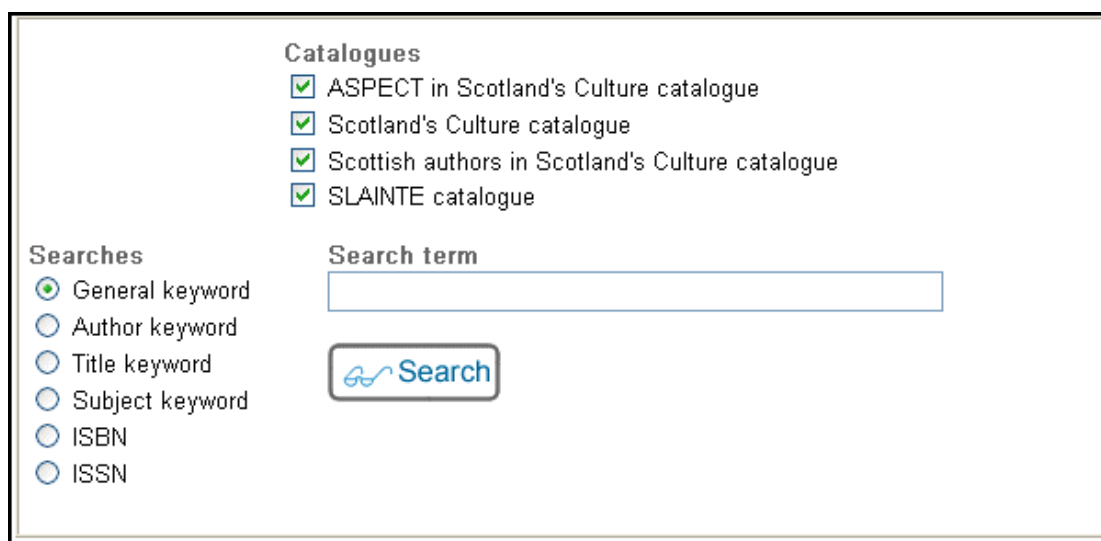

Catalogues

- ASPECT in Scotland's Culture catalogue
- Scotland's Culture catalogue
- Scottish authors in Scotland's Culture catalogue
- SLAINTE catalogue

Searches

- General keyword
- Author keyword
- Title keyword
- Subject keyword
- ISBN
- ISSN

Search term

Screen 2: Search input form for the Networked, open-access electronic resources miniclump (partial screen).

Portlet canned searches

A portlet interface to CAIRNS is being developed as part of the SPEIR project. This allows a search to be specified in URL parameters for identifying:

- Catalogues to be included.
- Index to be used.
- Search term.
- Miniclump identifier.

It is possible to create a URL for a “canned” search on CAIRNS with just the search term and a miniclump identifier, which in turn specifies the catalogues and index.

This is being tested by Scotland’s Culture⁷, the pilot cultural portal funded by the Scottish Executive. Canned subject searches on CAIRNS catalogues have been included in the portal’s browse section and can be invoked by clicking on a graphic or text label which contains the parameterised URL for the CAIRNS portlet.

An example is the canned search for music, which has the relative URL:

../zipacsrch.cfm?uMiniID=10&uZTrm=music

Here, the search term “music” is automatically entered into miniclump number 10, “Portal subject keywords”. This miniclump includes all CAIRNS catalogues and specifies the subject keyword index.

Miniclumps excluding no-hit catalogues

Another use of system-defined miniclumps is to exclude catalogues which return few or no hits during a canned search for a specific name or subject. First, the search is carried out on all CAIRNS targets, and those returning zero or a low number of hits are noted. A miniclump is then created which specifically excludes such low recall catalogues from the search. This can be important for improving search response times as well as overall recall, as noted in the report on transforming a clump into a Z39.50 server for CC-interop deliverable A3⁸.

The “Robert Burns” miniclump is an example shown in Screen 3. It is used in the Distributed National Burns Collection project.⁹

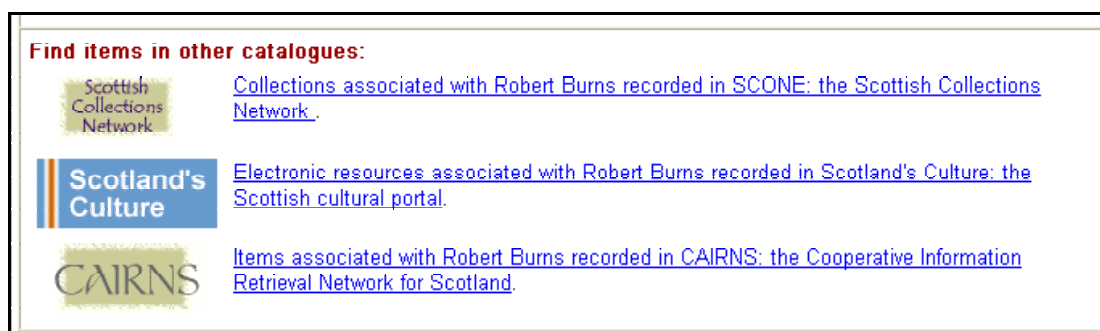

Screen 3: Portlet options in the demonstrator DNBC service (partial screen).

The graphics and hyperlinks use canned search URLs to the appropriate service.

The same method can be used to exclude those Z servers which are (temporarily) giving error messages in response to requests for a specified index. This has been used on several occasions during the addition of new catalogues to the CAIRNS service.

User defined miniclumps

Most of the miniclumps created for CAIRNS have been defined by groups of users rather than system administrators. Such groups can include librarians and other information professionals, and end-user groups.

Library defined miniclumps

Miniclumps can be defined by information professionals for use in collection management and development. Table 1 gives some examples from CAIRNS.

Miniclump title	Scope	Use
Napier document supply	Catalogues of libraries belonging to a local interlending service for higher education in the Edinburgh area.	Used by Napier University ILL librarians to check requests.
GAELS/CAIRNS	Catalogues of Strathclyde and Glasgow university libraries.	Used by staff of a project developing electronic document supply.
Napier Health Reclassification via ISBN	Catalogues of libraries with undergraduate collections in nursing and medicine classified by the Dewey Decimal Classification scheme.	Used for a project to reclassify Napier University library stock.

Table 1: Examples of library defined miniclumps in CAIRNS.

End-user defined miniclumps

Table 2 gives examples of miniclumps defined by end-user groups.

Miniclump title	Scope	Use
Scottish history collections	Catalogues of libraries in Scotland with good undergraduate and research collections in history.	Recommended by a group of lecturers.
Tayside university libraries	Catalogues of universities in the Tayside area with reciprocal access arrangements.	Used by students to identify materials which can be readily accessed.

Table 2: Examples of end-user defined miniclumps in CAIRNS.

Miniclump archive

Although miniclumps are a useful shortcut to sub-sets of catalogues which persist through time and are used over and over again, some are defined and used by groups that eventually cease to require them.

CAIRNS retains miniclumps no longer required for their original purpose, such as the “GAELS/CAIRNS” and “Napier Health Reclassification via ISBN” miniclumps, which were used by projects that have now ended. They are placed in an archive in case other users find them useful, and to illustrate the variety of miniclumps which can be created.

Miniclumps automatically ignore catalogues which are no longer part of CAIRNS, so archived miniclumps do not need to be redefined when a catalogue ceases to be a member of CAIRNS.

This means it is possible that an old, archived miniclump may contain no active catalogues at all. In that case, CAIRNS displays all of its catalogues for selection during the Survey stage.

Dynamic clumps

A dynamic clump is defined as:

- A sub-set of catalogues available in a clump. The sub-set may contain some or all catalogues, or it may be empty.
- Sub-set members share a common property, which is the defined scope of the dynamic clump.
- The sub-set has no persistence. It must be regenerated before it can be used again.

A dynamic clump is usually generated by an end-user in the Survey stage of using the IE.

Collection-level description and dynamic clumping

The creation of a dynamic clump involves identifying catalogues that share a common property. Some useful distinguishing characteristics are properties of the catalogues themselves, such as subject scheme, but many more are properties of the collections that the catalogues describe. Examples include physical or electronic location, language, and subject strength of collections.

Such properties can be stored and retrieved using CLDs.

Landscaping

“The information landscape can be seen as a contour map in which there are mountains, hillocks, valleys, plains and plateaux ...[it] is, however, multidimensional. Where one scholar may see a peak another may see a trough. The task is to devise mapping conventions which enable scholars to read the map of the landscape fruitfully, at the appropriate level of generality or specificity.”¹⁰

CLD provides a means of meeting this task. The required “mapping conventions” are those common properties of collections described in a standardised way to improve their usefulness in information retrieval.

This suggests that an effective landscaping service based on CLDs should allow the user to:

- Identify CLDs sharing common characteristics such as subject or language.
- Describe and relate CLDs in a coherent and consistent way.
- Traverse levels of granularity in CLDs.

Association of collection with catalogue

CLDs in a landscaping service must contain information about online finding aids to allow procedure to the Discovery stage. Heaney identifies four types of collection finding aids, or collection-descriptions:

- Unitary. A single CLD is an example.
- Analytical. A Library catalogue is an example. SCONE is an analytical collection-description for Scottish collections.
- Hierarchical. An archival finding-aid is an example.
- Index. A keyword index is an example.

The last three types are collections themselves, of metadata pertaining to items, and can be described with their own CLDs using a sub-set of the standard attributes.

SCONE

The Scottish Collections Network (SCONE)¹¹ is a service offering CLDs for Scottish collections.

SCONE was originally developed as part of the Research Support Libraries Programme (RSLP). The SCONE CLD schema is based closely on Heaney's analytic model. It treats online finding aids for collections (except the unitary type) as collections (of metadata) themselves, for example.

The service covers collections held in Scotland, irrespective of topic or material, and significant collections on Scottish topics held elsewhere. Collections held in libraries, archives, and museums are included.

The SCONE Landscape search is generally characterised with the IE model as:

- Entry: The set of all CLDs recorded in the SCONE database.
- Survey: Any sub-set that can be generated from the SCONE interface.
- Discover: CAIRNS dynamic clump and local online finding aid.
- Detail: CAIRNS and local standards.

Library collections

The SCONE coverage of library collections located in Scotland is comprehensive and detailed.

The Chartered Institute of Library and Information Professionals in Scotland (CILIPS)¹² publishes an annual directory, Scottish library and information resources (SLIR)¹³, containing the names, addresses, and contact details for most library and information organizations operating in Scotland. An old version of the database driving the directory was used to create about 1400 CLDs in SCONE during the SCONE project. Since the project, CILIPS has used the SCONE database to generate the printed directory, with the result that the CLDs are updated every year.

As part of the annual data checking and updating exercise, libraries are asked to supply information about their special, named collections for SCONE. The editors of the printed directory also carry out extensive cross-checking on library websites to verify URLs and contact details. Information about special collections is reviewed at the same time, and SCONE updated accordingly. In addition, members of the Scottish Library and Information Council (SLIC)¹⁴ and SCURL are asked to notify SCONE when they publish additional information about their collections on their websites.

Museum collections

The Scottish Museums Council (SMC) publishes an online directory of 340 museums in Scotland¹⁵. As part of the SPEIR project, the database driving the directory was used to create some 200 new CLDs for museum collections in SCONE. The other SMC entries were found to already have CLDs in SCONE, which were cross-checked and updated accordingly.

Archive collections

The SPEIR project has also allowed the checking and updating of CLDs for archives in SCONE, using information published on the Scottish Archives Network (SCAN)¹⁶.

Some details of the SPEIR work involving museums and archives have been published¹⁷.

User group collections

SCONE has been able to incorporate descriptions for collections defined by a number of user groups in Scotland.

The Directory of official publications in Scotland was digitised, updated, and published on behalf of the Scottish Working Group on Official Publications (SWOP)¹⁸ during the SCONE project.

The SWOP directory contains information about the collections of publications of governmental and inter-governmental organizations held by the 14 members of the Group. The information is structured with a high degree of granularity, with a depth of 6 layers of categorization from “National governments” to “Public general acts”. The directory was used to create just over a 1000 CLDs in SCONE.

Exploring Scottish history¹⁹, a directory of genealogical resources held in Scottish libraries, museums and archives, was derived from a database containing detailed descriptions of collection contents selected and defined by the Scottish Local History Forum, along with extensive notes relating to collection and location access. The database was used to create about 380 CLDs in SCONE.

Landscaping options

SCONE offers facilities for creating landscapes dynamically by searching for a common collection characteristic, and statically by specifying a pre-selected sub-set of CLDs.

Dynamic landscapes

Prior to the start of the CC-interop project, SCONE offered options for finding collections by:

- Title.
- Physical location.
- Associated persons and organizations.
- Library of Congress Subject Headings.
- Conspectus subject strength.

The first deliverable of CC-interop Work Package B was a report comparing the SCONE CLD schema with others in use in the United Kingdom²⁰. The report recommended a number of extensions to the SCONE database to accommodate CLD attributes found to be useful in other projects and services.

Most of the recommended changes to the SCONE database and schema have been undertaken. Appropriate changes to the SCONE service displays and SCAMP²¹ updating facility have also been completed, with the result that two new options for finding collections are available:

- Education or audience level.
- Language.

The SCONE CLD schema accommodates a number of other attributes that may be suitable for retrieving collections. There are insufficient data populating these attributes at this stage to justify offering finding options in the SCONE service:

- Graphic and realia medium.
- Medium of performance.
- Music notation.

The options for finding collections are used to create collection landscapes in the Survey stage of using the IE. Screen 4 shows the current SCONE options.

SCONE is the Scottish Collections Network. It provides descriptions of collections of all kinds held in libraries, museums, and archives in Scotland, as well as collections about Scottish topics held elsewhere. Use the links below to search for collections.

Find collections

by collection title	List titles A-Z Search for words in the title
by location	Map of regions of Scotland List Scottish regions and towns A-Z List all countries, regions, and towns A-Z List all towns A-Z
by people and organizations	List names A-Z Search for words in the name
by subject	List Library of Congress Subject Headings A-Z Search for words in subjects
by subject strength	List Conspectus subject thesaurus A-Z Search for words in Conspectus subjects
by language other than English	List languages A-Z
by education level	List MEG education levels

Screen 4: Menu of options for finding SCONE collections (partial screen).

Collection title

SCONE offers two options for finding collections by title: browsing the titles or searching for a word or phrase contained in the title.

List titles A-Z

This option displays an alphabetical list of the titles of all "top-level" collections in SCONE; that is, collections which are not a sub-collection of another collection. Sub-collections can be found by drilling down from the top level.

It is not useful to produce a list that contains all collection titles. This is due to scaling issues and the prevalence of organizational and other collections defined by functional granularity, many of which do not have a distinctive or special title. The titles of special collections can be found more easily using a keyword search.

This option can be used to identify high-level collections and their scope.

Search for words in the title

This option displays a list of all collection titles containing a word or phrase specified by the user. The system applies full truncation to the term when matching to the title. The system treats a specified phrase as a unit and not as a set of discrete words.

The option generates a landscape of collections with titles containing a word or phrase in common. Some tasks relevant to this landscape are:

- Identification of a specific collection when the exact title is not known.
- Creation of imprecise subject landscapes by matching an uncontrolled subject topic against uncontrolled titles. If the user identifies a match as relevant, controlled terms for subjects, persons, and organizations may be found within the CLD.

For example, the landscape specified by **Collection title contains "Burns"** contains around 15 collections, all of which are associated with the poet Robert Burns.

The limitations of keyword matching are illustrated by the landscape specified by **Collection title contains "Ramsay"** which is empty, and does not retrieve the Alexander Law collection associated with the poet Allan Ramsay.

Similarly, the Alexander Law collection itself has nothing to do with the subject of law, and would not be relevant to a landscape for legal materials.

Location

SCONE provides several options for generating landscapes based on the geographical location of collections. Locations are specified using a map or browsing the names of countries, regions, and towns.

Map

This option displays a clickable map of Scotland displaying the local authority regions, as shown in Screen 5.

When a region is selected SCONE displays an alphabetical list of collections located within the region. The map contains a list of region names, which can also be used to display the list.

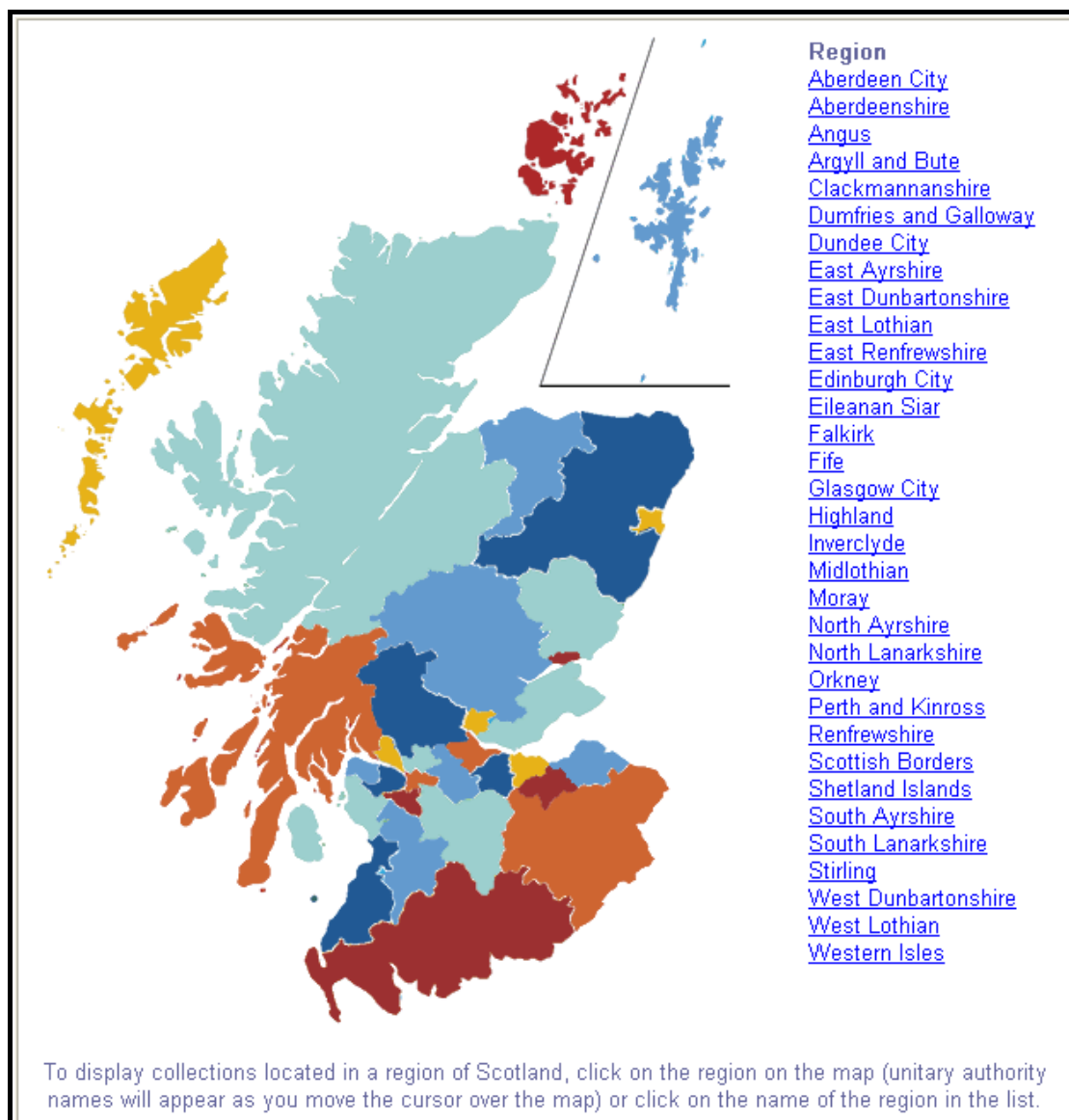

Screen 5: Clickable map of Scottish local authority regions for generating landscapes based on physical location (partial screen).

The option generates a landscape of collections located in a specific local government area. Some tasks relevant to this landscape are:

- Planning a visit to a particular region for study and research such as local and family history.
- Collaborative collection development in regional co-operatives.
- Planning and administration of regional information services.

List Scottish regions and towns A-Z

This option displays an alphabetical list of Scottish local authority regions. When a region is selected SCONE displays an alphabetical list of towns in the region. When one or more towns is selected SCONE displays an alphabetical list of collections located within the specified towns.

The option generates a landscape of collections located in a specific set of towns, in a specific local government area. Some tasks relevant to this landscape are:

- Restricting the landscape to resources that are located within a short distance of the user. This can be particularly useful in rural areas such as the Highland region.
- Planning a visit to a specific area for study and research, such as local and family history.

List all countries, regions and towns A-Z

This option displays an alphabetical list of countries where collections are located. When a country is selected SCONE displays a list of regions in that country. When a region is selected, SCONE displays an alphabetical list of towns in the region. When one or more towns is selected SCONE displays an alphabetical list of collections located within the specified towns.

The option generates a landscape of collections of Scottish interest located in a specified set of towns outside of Scotland.

List all towns A-Z

This option displays an alphabetical list of all towns in Scotland and those towns in other countries where collections are located. The list includes all Scottish cities, town, and villages, even if they are not the location of any collection. When a single town is selected SCONE displays a list of collections located within the specified town.

The option generates a landscape of collections located in a specific town. Some tasks relevant to this landscape are:

- Restricting the landscape to resources within the vicinity of the user.
- Planning a visit to a particular town for study and research, such as local and family history.
- Collaborative collection development in city-wide co-operatives.
- Planning and administration of city-wide information services.

Associated persons and corporate bodies

SCONE offers two options for finding collections associated with a particular person or organization: browsing their names or specifying a word or phrase in their names.

Persons and organizations are associated with collections based on their roles as:

- Current and previous collectors.
- Current and previous owners.
- Creators of items in the collection.
- Producers of items in the collection items.
- Subjects of a collection.
- Administrators of collection locations.

List names A-Z

This option displays an alphabetical list of all personal and organization names associated with collections. The list displays names in normalized form, so personal names are inverted with family name first. The list can be filtered by specifying one or more associations; for example the user can specify that only collectors and owners are to be displayed in the list. When a name is selected SCONE displays an alphabetical list of collections associated with the specified person or organization.

The option generates a landscape of collections associated with a specific person or organization in a specific role. Some tasks relevant to this landscape are:

- Landscaping of resources by or about a specific person or organization that are distributed in more than one collection and location.
- Identification of collections owned by a single organization such as a local authority.

For example, the landscape specified by **Associated name is Robert Burns (1759-1796)** contains all collections with a special focus on the poet Robert Burns.

Similarly, the landscape specified by **Associated name is Falkirk (Scotland). Council** contains the museum and public and school library collections owned by Falkirk local authority.

Search for words in the name

This option displays an alphabetic list of persons and organizations with names containing a word or phrase specified by the user. The system applies full truncation to the user term when it is matched to the name. The system treats a specified phrase as a unit and not as a set of discrete words. The user can restrict the match to right truncation to find names beginning with the term. When a name is selected SCONE displays an alphabetical list of collections associated with the specified person or organization.

The option generates a landscape of collections associated with a person or organization when the name is only partially known or the spelling is uncertain. The option can also be used to identify organizations with a common designation in their name.

Subject

SCONE offers two options for finding collections by subject using Library of Congress Subject Headings: browsing the topics or searching for a word or phrase contained in the heading.

List Library of Congress Subject Headings A-Z

This option displays an alphabetical list of topics conforming to Library of Congress Subject Headings. The list includes geographic topics, and the normalized forms of the names of persons and organizations who are the subjects of collections. The user can restrict the list to names, or subject and geographic topics. When a topic is selected SCONE displays an alphabetical list of collections of items with the specified topic as a subject.

The option generates a landscape of collections on a specific subject or name topic. Some tasks relevant to this landscape are:

- Study and research on a specific subject.
- Collaborative collection management.

Search for words in subjects

This option displays an alphabetic list of topics conforming to Library of Congress Subject Headings containing a word or phrase specified by the user. The system applies full truncation to the user term when it is matched to the topic. The system treats a specified phrase as a unit and not as a set of discrete words. When a topic is selected SCONE displays an alphabetical list of collections with the specified topic as a subject.

The option generates a landscape of collections on a specific subject when the exact topic is not known. A task relevant to this landscape is:

- Identification of collections with subjects with a common geographical or historical designator.

Subject strength

SCONE provides options for identifying collections by subject strength using data from the Research Collections Online (RCO) service²².

RCO is a Conspectus analysis of subject strengths of the libraries of the Scottish Confederation of University and Research Libraries (SCURL)²³. The original analysis was carried out in 1988 and has since been updated by the SEED project²⁴.

List Conspectus subject thesaurus A-Z

This option displays an alphabetic list of subject divisions from the top level of the Conspectus thesaurus. When a division is selected, SCONE displays an alphabetic list of subject categories in the specified division. When a category is selected, SCONE displays an alphabetic list of subjects in the specified category. When a subject is selected and optional Conspectus levels specified, SCONE displays a list of collection titles with the specified Conspectus strength in the specified subject.

The option generates a landscape of general collections with strengths at a specific level in a specific subject. Some tasks relevant to this landscape are:

- Study and research on a specific subject.
- Planning for part-time, distance, and vacation study and research.
- Collaborative collection management.
- Collaborative collection access.

For example, the landscape specified by ***Collections with level 3 strength in adult education*** contains collections aimed at instructional support in the teaching of medical anatomy.

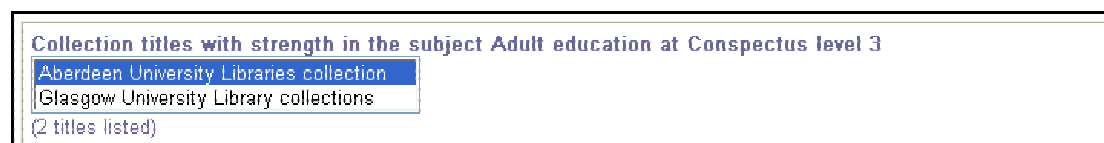

Screen 6: The landscape of collections with level 3 strength in adult education (partial screen).

Search for words in Conspectus subjects

This option displays an alphabetic list of Conspectus subject terms containing a word or phrase specified by the user. The system applies full truncation to the user term when it is matched to the name. The system treats a specified phrase as a unit and not as a set of discrete words. When a subject is selected and optional Conspectus levels specified, SCONE displays an alphabetical list of collections with the specified Conspectus strength in the specified subject.

The option allows the user to identify Conspectus subjects when their categorization is not known, before creating a landscape based on subject strength.

Language

SCONE provides an option to find collections with a significant proportion of items using a specific language.

English is excluded on the assumption that items in most collections will be written, spoken or sung in English.

List languages A-Z

This option displays an alphabetical list of languages, other than English, used in text or sound items in collections.

The option generates a landscape of collections of items written, printed, and recorded in a specific non-English language. Some tasks relevant to this option are:

- Study and teaching of non-English languages.
- Improving the social inclusion of groups who have English as a second language.
- Planning and administration of programs to encourage the use of Gaelic in Scotland.

For example, the landscape specified by **Collection language is Scots Gaelic** shown in Screen 7 contains collections where a significant number of items written, printed, spoken, or sung in Gaelic can be found.

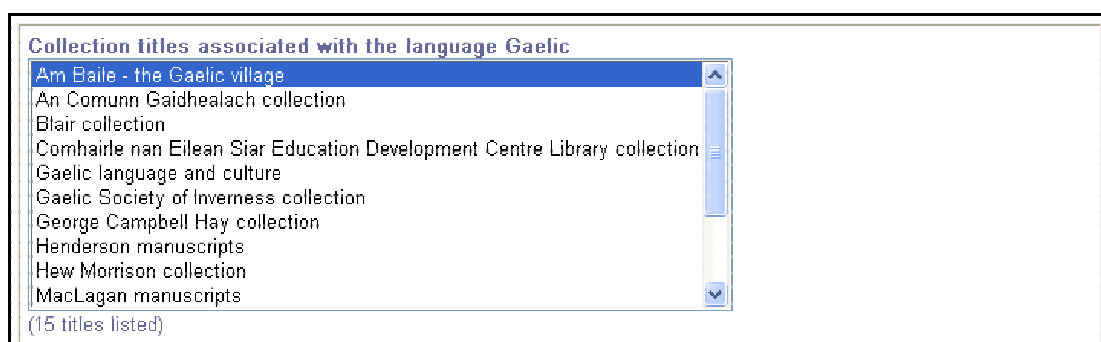

Screen 7: The landscape of collections with language Scots Gaelic (partial screen).

Education level

SCONE provides an option to find collections intended for users at one or more levels of education.

The levels in current use are based on those proposed by the Metadata in Education Group (MEG).

List MEG education levels

This option displays a ranked list of education levels as determined by MEG. When a level is selected SCONE displays a list of collections aimed at the specified education level.

The option generates a landscape of collections intended to support learners at a particular level. Some tasks relevant to this landscape are:

- Collaborative management and access to collections in a specific educational sector.

Static landscapes

Sets of CLDs can be specified for SCONE in a similar way to miniclumps in CAIRNS, using the SCAMP interface.

These sets are not currently available in the public service for direct access by users. They are being tested for use in a portlet interface to SCONE, using URLs with embedded search parameters similar to those available for CAIRNS. This is being developed as part of the SPEIR project.

SCONE Collection-level descriptions

SCONE allows the display of a complete or partial CLD for a specific collection belonging to any of the landscapes generated by the user.

A CLD can be displayed for any collection at any level of granularity. The CLD is composed of a number of elements including:

- General description.
- Administrative history.
- Location.
- Related persons and organizations.
- Related collections.
- Subjects.
- Catalogues.

The user can specify which of these elements are to be included in the CLD display. This can remove unwanted detail to give a shorter, less cluttered display.

In many CLDs elements are inherited from one or more parent collections at a higher level. Inherited elements include:

- Location.
- Owners.
- Catalogues.

Screen 8 shows a typical CLD from SCONE.

Description	A small collection of 25 books from the library of John Buchan (1875-1940), first Baron Tweedsmuir, which was presented to the Library in 1940 and contains his bookplates. All the items in the bequest relate to James Graham (1612-50), the first Marquis of Montrose, and to the history of Scotland after the declaration of the National Covenant and during the Civil War; the collection includes 13 Wiving items. Montrose featured in several of Buchan's books and lectures and was the subject of one of his earliest historical works, <i>The Marquis of Montrose</i> (1913), which was unfavourably criticized due to the author's idealized portrayal of its subject (a revised biography, <i>Montrose</i> , was published in 1928). Two collections of manuscript material relating to John Buchan, were successively presented and deposited by his son, the second baron Tweedsmuir, in 1977 and 1985.			
Size	25 v. + mss.			
Notes	Typescript inventories of the manuscripts.			
Local identifier	Tw.			
Type	Collection.Library.Text			
Administrative history	Date	Transferred from	To	Terms
	1940	John Buchan (Baron Tweedsmuir) (1875-1940)	National Library of Scotland	Bequest.
	1977	Tweedsmuir (2nd Baron)	National Library of Scotland	Donation.
	1985	Tweedsmuir (2nd Baron)	National Library of Scotland	Donation.
Location	National Library of Scotland George IV Bridge Edinburgh (City of Edinburgh, Scotland) EH1 1EW			
	City centre location, Waverley rail station, bus station nearby; on bus routes; parking nearby; disabled access.			
Access	Direct access is limited to specific groups.			
Contacts	National Library of Scotland			
Collectors	John Buchan (Baron Tweedsmuir) (1875-1940) [Collecting: Closed]			
Item creators	John Buchan (Baron Tweedsmuir) (1875-1940)			
Owners	National Library of Scotland			
Subjects	James Graham Montrose (Marquis of) (1612-1650)			
Part of	National Library of Scotland collection (main)			
Catalogues	National Library of Scotland catalogue			

Screen 8: Collection-level description for the Tweedsmuir collection (partial screen).

In this example of a CLD, the information about the location (including contacts), the owner, and the catalogues is inherited from a super-collection.

The SCONE CLD display includes a number of features to connect it to other stages of retrieval in the IE.

CLD and the Discovery stage

The CLD provides connection to the Discovery stage using hyperlinks to online digital collections and finding aids.

The screenshot shows a web interface for the Springburn virtual museum. At the top, there are navigation buttons for 'Home' (with a house icon), 'Springburn virtual museum' (the title), and 'Help' (with a question mark icon). Below these are two more buttons: 'Online Catalogues' (with a document icon) and 'Super Collections' (with a tree icon). The main content area is a table with the following entries:

Description	A representative selection of digitised materials from the Springburn Community Museum, which closed in 2001 because of funding problems. Images for the collection have been chosen to convey important elements of the social and economic history of Springburn. Particular emphasis has been placed upon the railway industry and community and tenement life in Springburn.
Type	Collection.Library.Text.Image.Special.Virtual
Location	Springburn Virtual Museum
Part of	Glasgow digital library
Catalogues	Springburn Virtual Museum: Index of all images

Screen 9: Collection-level description for the Springburn virtual museum (partial screen).

SCONE displays a hyperlink to the electronic location if the CLD is for a collection of digital objects. An example is shown in Screen 9

SCONE displays a hyperlink to online catalogues or other finding aids associated with the collection. In Screen 9, the index of images is a finding aid with a slightly different location from the collection.

Many digital collections, unlike the example of the Springburn virtual museum, have finding aids at the same electronic location as the collection itself. In these cases the hyperlink to the collection location and catalogues is identical.

Inheritance and finding aids

SCONE assumes that the catalogue of a collection is also a finding-aid for all of the sub-collections. This justifies the inheritance of catalogue information from a super-collection by the CLD for a sub-collection.

In cases where this is known to be untrue, for example where hybrid collections of books and manuscripts are separately catalogued in a book or manuscript catalogue, the concept of “functional granularity” defined by Heaney allows SCONE to create service-defined intermediate collections to alleviate some resulting problems.

For example, where separate book and manuscript catalogues exist, the actual hybrid collection (say Collection A) can be divided into two service-defined sub-collections: one for *Collection A books*, and the other for *Collection A manuscripts*. At the same time, functional granularity indicates that there are two super-collections defined as “all manuscript collections described in the manuscripts catalogue” (say *Manuscripts collection*) and “all book collections described in the books catalogue” (say *Books collection*).

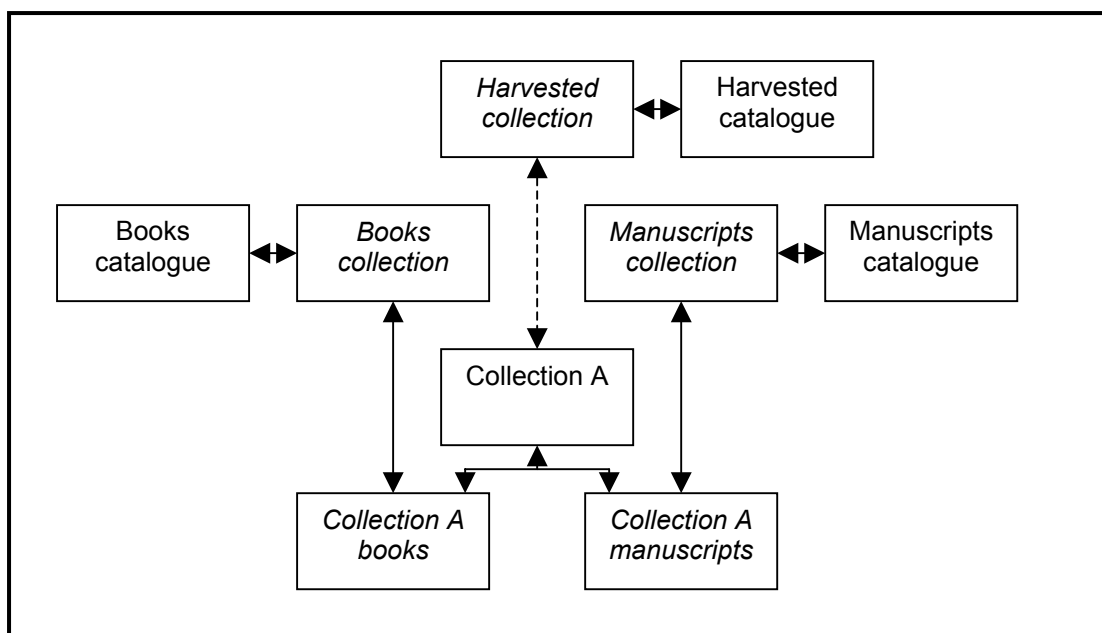

Diagram 1: Functional granularity, collection hierarchy, and inheritance.

Diagram 1 shows the resulting SCONE collection hierarchy. System-defined collections are given in italics.

Catalogues are recorded in the SCONE database with their own CLDs, following Heaney's model. These collection-description CLDs are never made directly accessible to the user, but are displayed as part of the CLD of the associated collection.

In this example, the CLD for Collection A will not display a catalogue (ignoring the dotted connection), but the CLD for the sub-collection *Collection A books* will display a link to the Books catalogue, and the CLD for the sub-collection *Collection A manuscripts* will display a link to the Manuscripts catalogue.

It is possible that Collection A itself is part of a super-collection which has its own catalogue separate from the Books catalogue or the Manuscripts catalogue. This might occur, for example, if the metadata from the Books and Manuscripts catalogues are harvested or otherwise copied into a larger union catalogue, as shown by the dotted line in Diagram 1.

In such a case, the Harvested (union) catalogue would be displayed in the CLD for Collection A, if it was appropriately recorded and linked in SCONE. This would mean that the sub-collection *Collection A books* could then inherit catalogue information from two sources, the Harvested catalogue (via Collection A) and the Books catalogue (via the *Books collection*).

The SCONE CLD displays those catalogue(s) which are the most co-extensive with the collection; that is, the least number of hierarchical levels away. Catalogues for higher level aggregations of collections are not displayed for several reasons:

- It may be confusing for the casual or non-expert user.
- Increasing recall may not be advantageous to the user. For example, when searching two high-level aggregations of metadata with a large overlap, many duplicates may be retrieved which slow down the search without broadening it. This point is noted in the CC-interop report for deliverable A4, on establishing and testing the InforM25 clump as a target from COPAC²⁵.
- It is assumed that precision in search results is unlikely to improve significantly at higher levels of aggregation of item-level metadata.

- It is likely that precision will significantly decline for some types of high level aggregation, for example union catalogues harvested using OAI-PMH, with a lossy transformation of metadata from, say, MARC21 to DC.
- Higher level aggregations may include collections outside of the scope of the service. Although this broadens recall, it may introduce noise to, or conflict with, the service presentation of the Detail stage of the IE. For example, general access information may be given for “all university libraries”, with the assumption that this is subject to the overall scope of SCONE and means all Scottish university libraries. A high level aggregation of UK university library collection metadata will retrieve items from libraries which are not part of any such Scottish access arrangements.

In the example the CLD for *Collection A books* would display only a link to the Books catalogue. The union catalogue would be at least one further hierarchical level away because Collection A itself would have at least one super-collection: the aggregated collection defined as being catalogued by the union catalogue.

Cases arise when there is more than one catalogue at the same lowest level of aggregation, for example when item-level metadata is harvested from a static repository that has no local retrieval interface. If harvested by more than one aggregation service within SCONE, the resulting super-collection finding aids will be the same number of functional granularity levels away from the CLD. When this happens, the CLD displays all of the super-catalogues.

CLD and the Detail stage

The SCONE CLD displays information about location opening hours and accessibility to inform the Detail stage of the IE. Such information allows the user to determine the circumstances under which copies of a resource held at different locations may be consulted or borrowed.

The standard display also includes the name of the location administrator, if available. The name is labelled “Contacts”, and contains a hyperlink to details of the telephone and fax numbers and email and homepage addresses of the agent. This information can be used to make more detailed enquiries about specific collections and resources.



Screen 10: Contact details for the National Library of Scotland (partial screen).

An example is shown in Screen 10, which is displayed from the hyperlink for Contacts shown in Screen 8.

CLD and the Survey stage

SCONE offers a number of ways of generating new landscapes from information contained in an individual CLD.

Landscapes related by location

The CLD includes a hyperlink from the town or city of the location, where applicable. The hyperlink generates a landscape of all top-level collections located in the same town or city.

[Home](#) **Collection descriptions** [Help](#)

Collection titles located in Edinburgh

- Action on Smoking and Health Scotland collection
- Advice Service Capability Scotland (ASCS) collection
- Advocates' Library collection
- Age Concern Scotland Library collection
- Alzheimer Scotland Action on Dementia National Office collection
- Architectural Heritage Society of Scotland ESH collection
- Balgreen Library collection
- Bank of Scotland Archives Department collection
- Bank of Scotland Museum collection
- Blackhall Library collection

(227 titles listed)

Display detail [Show](#) Select a collection title and check which details to display, then click the Show button.

- General description
- Administrative history
- Location
- Related persons and organizations
- Related collections
- Subjects
- Catalogues

Collection types [Limit](#) Check which types of collection to list, then click the Limit button.

- Archive
- Library
- Museum
- Internet

[CAIRNS Catalogues](#) [Online Catalogues](#) Click the CAIRNS Catalogues button to search for items in the listed collections using the Cooperative Information Retrieval Network for Scotland. Click the Online Catalogues button to search for items in the listed collections using other online catalogues.

Screen 11: The landscape of collections located in Edinburgh (partial screen).

Screen 11 shows the landscape generated from the hyperlink for Edinburgh shown in Screen 8.

Landscapes related by agent

The CLD includes hyperlinks from the names of collectors, owners, and subjects, where applicable. Each hyperlink generates a landscape of all collections associated with the same name, in any role.

Collection titles associated with John Buchan (Baron Tweedsmuir) (1875-1940)

- John Buchan Centre Broughton collection
- Tweedsmuir collection

(2 titles listed)

Screen 12: The landscape of collections associated with John Buchan (partial screen).

Screen 12 shows the landscape generated from the hyperlink for John Buchan shown in Screen 8.

Landscapes associated with persons display information about the person, including biography, and contact details (not shown in Screen 12).

Collection titles associated with Highland (Scotland). Council

- Am Baile - the Gaelic village
- Highland Council Archive collection
- Highland Council libraries collection
- Highland sites and monuments record (SMR)
- North Highland Archive collection

(5 titles listed)

Display detail

- General description
- Administrative history
- Location
- Related persons and organizations
- Related collections
- Subjects
- Catalogues

 Select a collection title and check which details to display, then click the Show button.

Collection types

- Archive
- Library
- Museum
- Internet

 Check which types of collection to list, then click the Limit button.

 **CAIRNS Catalogues**

 **Online Catalogues**

Click the CAIRNS Catalogues button to search for items in the listed collections using the Cooperative Information Retrieval Network for Scotland.

Click the Online Catalogues button to search for items in the listed collections using other online catalogues.



The Highland Council
Comhairle na Gàidhealtachd
SERVING The Highland Community

Organizational details for Highland (Scotland). Council

Homepage <http://www.highland.gov.uk/>

Screen 13: The landscape of collections associated with Highland Council (partial screen).

Landscapes associated with organizations display information about the organization, including history, logo, and contact details. An example is shown in Screen 13.

Landscapes related to collection hierarchy

The SCONE CLD includes hyperlinks from the names of super- and sub-collections, as shown in Screen 8 and Screen 9. Each hyperlink generates a landscape of the super- or sub-collections of the current collection.

These hyperlinks are also available as graphic buttons on the CLD display, as shown in Screen 9. This allows quick browsing of collection hierarchies even if the “Related collections” element of the display has been turned off by the user.

Discovery from the landscape

Once a landscape of collections has been identified or created during the Survey stage of the IE, it can be used to control the Discovery stage, which retrieves information about items held in the specified collections.

SCONE provides two methods of moving from Survey to Discovery. The first creates a miniclump of CAIRNS catalogues for the collections in the landscape, allowing a one-stop, seamless search for items in those catalogues. The second creates a list of local online catalogues for the collections that can be searched serially for items.

Seamless Discovery

The IE envisages the use of physical or distributed union catalogues that can be searched in one go from a single interface in the Discovery stage.

There is little point in using the Survey stage, however, if the scope of the search has to extend to the entire union catalogue. For the landscape to be effective, the union catalogue must have the capability of restricting a search to subsets of the individual, albeit high-level, collections it describes.

CAIRNS is an example of such a union catalogue. It is composed of catalogues for high-level institutional collections, and the static and dynamic clumping facilities allow subsets of the catalogues to be specified.



Work Package B of the CC-interop project has developed a machine-to-machine interface which creates dynamic miniclumps in CAIRNS from collection landscapes created in SCONE.

The interface can be invoked using a button (CAIRNS Catalogues) on the SCONE collection landscape display, as shown in Screen 11 and Screen 13.

The interface takes each collection in the landscape and tries to identify a CAIRNS catalogue describing the collection at the same or higher level of granularity. That is, the super-collection hierarchy is checked at each level until an associated CAIRNS catalogue is found.

It is highly likely that more than one collection in the landscape will be described by the same CAIRNS catalogue because of the high-level of aggregation of collections described by a single organizational catalogue. SCONE therefore consolidates the generated miniclump so that users can see clearly when multiple collections are associated with the same catalogue.

It is also likely that some collections in the landscape will not have an associated CAIRNS catalogue because of the relatively low use of Z39.50 outside of the university and national library sector.

 Home
CAIRNS catalogues for selected collections
 Help

Collection titles located in Edinburgh

- Edinburgh University Library catalogue**
 Select to search for items belonging to the following selected collections:
 Edinburgh University Artificial Intelligence Library collection
 Edinburgh University Chemistry Library collection
 Edinburgh University Darwin Library collection
 Edinburgh University Erskine Medical Library collection
 Edinburgh University James Clerk Maxwell Library collection
 Edinburgh University Law and Europa Library collection
 Edinburgh University Main Library collection
 Edinburgh University Moray House Library (Education) collection
 Edinburgh University New College Library (Divinity) collection
 Edinburgh University Psychiatry Library collection
 Edinburgh University Reid Music Library collection
 Edinburgh University Robertson Engineering Library collection
 Edinburgh University Scottish Studies Library collection
 Edinburgh University Veterinary Library collection
 Lothian health services archive
 Moray House Library (Faculty of Education) collection
 Royal Hospital for Sick Children Library collection
 Royal Infirmary of Edinburgh Postgraduate Library collection
- National Library of Scotland general collections catalogue**
 Select to search for items belonging to the following selected collections:
 National Library of Scotland Map Library collection
 National Library of Scotland collection (main)
- Queen Margaret University College library catalogue**
 Select to search for items belonging to the following selected collections:
 Queen Margaret University College Corstorphine Campus Library collection
 Queen Margaret University College Leith Campus Library collection
- Scottish Poetry Library catalogue**
 Select to search for items belonging to the following selected collections:
 Scottish Poetry Library collection

 Search CAIRNS Select one or more catalogues, then click the Search CAIRNS button.

There are no CAIRNS catalogues for the other collections in the selection.

 Collection Descriptions Click the Collection Descriptions button to display more information about the listed collections.

Screen 14: Dynamic CAIRNS miniclump generated by the landscape of collections located in Edinburgh (partial screen).

Screen 14 shows the miniclump generated from the landscape shown in Screen 11.

The miniclump can be modified on this screen by de-selecting catalogues.

The Search CAIRNS button invokes the miniclump in the CAIRNS service, where it can be further modified by adding catalogues that lie outside of the scope of the original collections landscape. This allows the user a considerable degree of control over what is searched in the Discovery stage.

Server availability

The availability of Z39.50 catalogues is subject to disruption when:

- The local Z server is turned off for maintenance
- The local catalogue database or library management system is being upgraded.
- The local library management system is being replaced.

The inclusion of an inactive Z server in a broadcast search can have an adverse effect on:

- Search response time, as the unresponsive server is polled by the clump
- User time in reading error messages
- User confidence in the service

The CAIRNS service does not currently offer automatic management of inactive Z servers. A manual facility is used to change the status of a Z server record using the SCAMP interface.

This facility is used when the CAIRNS service is notified of planned disruption by the local service. The status of the server is reset to normal when it becomes available again.

The SCONE database uses as simple flag to indicate whether a Z server is inactive.

Inactive records are filtered from relevant CAIRNS and SCONE displays. The system automatically ignores inactive servers when creating and using static and dynamic miniclumps.

Multiple servers for one collection

Work Package B has specifically investigated the issues involved in using CLDs for landscaping when metadata for a single collection is available from multiple Z servers.

This situation arises when CAIRNS and COPAC are included in an extended information environment. A similar situation will occur if an IE includes two or more union catalogues with a common membership.

COPAC²⁶ is a physical union catalogue which copies metadata from the local catalogues of its contributors. Those contributors include four Scottish libraries:

- Aberdeen University Library
- Edinburgh University Library
- Glasgow University Library
- National Library of Scotland

All four libraries are also members of CAIRNS.

A Z server for COPAC was made available to the CC-interop project. With the COPAC target included in CAIRNS, the catalogue records of these libraries became available in two separate CAIRNS targets: their existing CAIRNS server and the COPAC server.

A CLD was created in SCONE for the COPAC collection, defined using functional granularity as the collection of all items described in the COPAC catalogue. This is an example of a distributed collection, “a collection that is shared among several libraries”, as defined in the CLDT enumerated list of collection types²⁷.

This COPAC collection is also a super-collection of the four CAIRNS libraries, each of which has its own CLD in SCONE.

Home	COPAC collection	Help
Online Catalogues	Sub Collections	
Description	Materials held by members of the Consortium of University Research Libraries (CURL).	
Type	Collection.Library.Text.Distributed	
Contains	Aberdeen University Libraries collection Edinburgh University Library collection Glasgow University Library collections National Library of Scotland collections	
Catalogues	COPAC	

Screen 15: Collection-level description for the COPAC collection (partial screen).

Screen 15 shows a minimal CLD for the COPAC collection. Description and Type are the only mandatory fields in the SCONE schema; the Contains and Catalogues fields are derived from related CLDs.

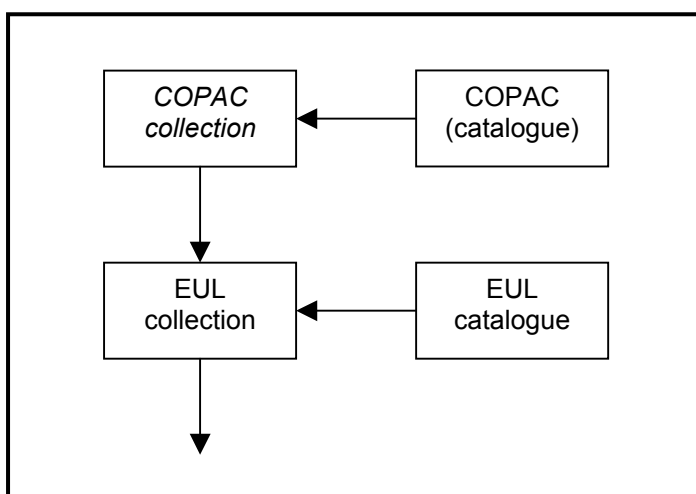

Diagram 2: COPAC collection hierarchy

Diagram 2 shows part of the hierarchy of CLDs for the COPAC collection. Again, the system-defined collections are given in italics. The Edinburgh University Library (EUL) collection is a sub-collection of the COPAC collection. Each collection has its own, co-extensive catalogue; each catalogue has a local interface and a Z server. The EUL collection itself has sub-collections.

As explained for Diagram 1, only catalogues for the lowest level aggregation of the collection are displayed in the SCONE CLD.

This means that the CLD for the EUL collection does not disclose the COPAC catalogue, as shown in Screen 16. It displays only a link to the EUL catalogue because it is closer in the hierarchy.

Home

Edinburgh University Library collection

Help

Online Catalogues

Super Collections

Sub Collections

Description	The collection supports the learning, teaching and research interests of Edinburgh University.
Education levels	Undergraduate Postgraduate
Type	Collection.Library.Text.Distributed
Collectors	Edinburgh University Library [Accrual: policy is Active; periodicity is Continuous; method is Deposit and purchase]
Owners	Edinburgh University
Part of	CAIRNS collection COPAC collection
Contains	Edinburgh University Artificial Intelligence Library collection Edinburgh University Chemistry Library collection Edinburgh University CTVM (Centre for Tropical Veterinary Medicine) Library collection Edinburgh University Darwin Library collection Edinburgh University Easter Bush Veterinary Centre Library collection Edinburgh University Erskine Medical Library collection Edinburgh University James Clerk Maxwell Library collection Edinburgh University Law and Europa Library collection Edinburgh University Main Library collection Edinburgh University Moray House Library (Education) collection Edinburgh University New College Library (Divinity) collection Edinburgh University Psychiatry Library collection Edinburgh University Reid Music Library collection Edinburgh University Robertson Engineering Library collection Edinburgh University Scottish Studies Library collection Edinburgh University Veterinary Library collection Moray House Library (Faculty of Education) collection Royal Hospital for Sick Children Library collection Royal Infirmary of Edinburgh Postgraduate Library collection W.H. Playfair drawings
Catalogues	Edinburgh University Library online catalogue

Screen 16: Collection-level description for Edinburgh University Library collection (partial screen).

Note that SCONE treats CAIRNS in the same way as it treats COPAC. The CAIRNS Z client is the local online catalogue for the CAIRNS collection, defined through functional granularity as the collection of all items described by the CAIRNS clump. The CAIRNS collection is related as a super-collection of EUL in the same way that COPAC is.

Although COPAC and CAIRNS are aggregated as union catalogues in quite different ways, SCONE is able to present them as functionally equivalent.

This is an example of polyhierarchy, when a collection can have more than one super-collection as well as more than one sub-collection. In practice, all super-collections bar one must be of distributed type. That is, a collection can be part of any number of distributed collections, but no more than one physical collection. In the example, both super-collections (CAIRNS and COPAC) are distributed, as is the EUL collection itself (Edinburgh University has a multi-campus library service).

The SCONE CLD displays only local online catalogues. It does not disclose Z39.50 catalogues directly.

Z server catalogues are treated in the same way with respect to collection hierarchy. The SCONE dynamic miniclump interface discloses only the Z target at the lowest level of a collection hierarchy. This is shown in Screen 14, which does not display COPAC as a target for the EUL and NLS collections.

If a lower level target were to be removed, the miniclump would disclose the higher level target in its place. This is shown in Screen 17, generated by briefly flagging the EUL target as inactive for demonstration purposes.

Collection titles located in Edinburgh

- COPAC**
Select to search for items belonging to the following selected collections:
 - Edinburgh University Artificial Intelligence Library collection
 - Edinburgh University Chemistry Library collection
 - Edinburgh University Darwin Library collection
 - Edinburgh University Erskine Medical Library collection
 - Edinburgh University James Clerk Maxwell Library collection
 - Edinburgh University Law and Europa Library collection
 - Edinburgh University Main Library collection
 - Edinburgh University Moray House Library (Education) collection
 - Edinburgh University New College Library (Divinity) collection
 - Edinburgh University Psychiatry Library collection
 - Edinburgh University Reid Music Library collection
 - Edinburgh University Robertson Engineering Library collection
 - Edinburgh University Scottish Studies Library collection
 - Edinburgh University Veterinary Library collection
 - Lothian health services archive
 - Moray House Library (Faculty of Education) collection
 - Royal Hospital for Sick Children Library collection
 - Royal Infirmary of Edinburgh Postgraduate Library collection
- National Library of Scotland general collections catalogue**
Select to search for items belonging to the following selected collections:
 - National Library of Scotland Map Library collection
 - National Library of Scotland collection (main)
- Queen Margaret University College library catalogue**
Select to search for items belonging to the following selected collections:
 - Queen Margaret University College Corstorphine Campus Library collection
 - Queen Margaret University College Leith Campus Library collection
- Scottish Poetry Library catalogue**
Select to search for items belonging to the following selected collections:
 - Scottish Poetry Library collection

 Select one or more catalogues, then click the Search CAIRNS button.

There are no CAIRNS catalogues for the other collections in the selection.

Screen 17: Dynamic CAIRNS miniclump generated by the landscape of collections located in Edinburgh, with Edinburgh University Library inactive (partial screen).

COPAC is given as a Z target for the EUL collections, and thus acts as a back-up service for the CAIRNS clump. This is a useful feature during periods of server disruption.

Note that COPAC is not given as a Z target for the NLS collections because each collection hierarchy is processed independently, and in this case the lower level NLS Z target is active.

Use of this miniclump will result in the retrieval of duplicate metadata for the same item in the NLS because the COPAC search includes the metadata from all contributing members, which includes the NLS.

Serial Discovery

Collections in HE and national libraries are likely to be found in a dynamic CAIRNS miniclump because of the high coverage of Z39.50 catalogues in these sectors. The situation in Scotland is the opposite for collections in other library sectors, and the archive and museum domains in general. Compatible, cross-searchable finding aids are not currently available, and consequently most items in the common Scottish IE cannot be found using union catalogues of any type.

Current steps to alleviate this include:

- Extension of CAIRNS to Scottish public libraries. This is currently underway as part of the SPEIR project.
- Integration of OpenURL databases in the CAIRNS client. This is a planned upgrade.
- Addition of the HaIRST harvested union catalogue to CAIRNS. This is a planned deliverable²⁸.



This will not completely resolve the problem, and many important items will remain outside the scope of unified finding aids for the foreseeable future.

The SCONE collection landscape can be used to generate a consolidated list of finding aids, a **pseudoclump**. The list provides the user with a map of the Discovery stage but with limited assistance within it.

Each finding aid has to be used with a local interface during the Discovery stage. Each finding aid has to be searched serially, and there is no co-ordination of results sets.

Screen 18 and Screen 19 show the pseudoclump for the same landscape as Screen 14. As usual, only lowest level aggregate catalogues for each collection are shown.

Many more collections can be searched using the pseudoclump than the seamless miniclump, but with more inconvenience for the user.

 [Home](#)**Online catalogues for selected collections** [Help](#)

Collection titles located in Edinburgh

Catalogue of the Russell collection
[Catalogue of the Russell Collection](#)
Use to search for items belonging to the following selected collections:
Russell collection of early keyboard instruments collection

Edinburgh City Libraries and Information Services catalogue
[Edinburgh City Libraries and Information Services catalogue](#)
Use to search for items belonging to the following selected collections:
Balgreen Library collection
Blackhall Library collection
Colinton Library collection
Corstorphine Library collection
Craigmillar Library collection
Edinburgh City Libraries and Information Services. Access Services collection
Edinburgh City Libraries and Information Services. Central Library collection
Edinburgh City Libraries and Information Services. Ethnic Library Service collection
Edinburgh City Libraries and Information Services. Hospital Community Library, Western General Hospital collection
Edinburgh City Libraries and Information Services. Hospital Community Library: Liberton Hospital collection
Fountainbridge Library collection
Gilmerton Library collection
Granton Library collection
Leith Community Library collection
McDonald Road Library collection
Moredundun Library collection
Morningside Library collection
Muirhouse Library collection
Newington Library collection
Oxgangs Library collection
Piershill Library collection
Portobello Library collection
Ratho Library collection
Sighthill Library and Learning Centre collection
Stockbridge Library collection
Wester Hailes Community Library collection

Edinburgh College of Art Library Service online catalogue
[Catalogue: Edinburgh College of Art Library Service online catalogue](#)
Use to search for items belonging to the following selected collections:
Edinburgh College of Art Library collection

Edinburgh University Library catalogue
[Edinburgh University Library online catalogue](#)
Use to search for items belonging to the following selected collections:
Edinburgh University Artificial Intelligence Library collection
Edinburgh University Chemistry Library collection
Edinburgh University Darwin Library collection
Edinburgh University Erskine Medical Library collection
Edinburgh University James Clerk Maxwell Library collection
Edinburgh University Law and Europa Library collection
Edinburgh University Main Library collection
Edinburgh University Moray House Library (Education) collection
Edinburgh University New College Library (Divinity) collection
Edinburgh University Psychiatry Library collection
Edinburgh University Reid Music Library collection
Edinburgh University Robertson Engineering Library collection
Edinburgh University Scottish Studies Library collection
Edinburgh University Veterinary Library collection
Moray House Library (Faculty of Education) collection
Royal Hospital for Sick Children Library collection
Royal Infirmary of Edinburgh Postgraduate Library collection

Screen 18: Finding aids for the landscape of collections located in Edinburgh: first half of list (partial screen).

Heriot-Watt University Library catalogue
[Heriot-Watt University WebPAC](#)
Use to search for items belonging to the following selected collections:
Heriot-Watt University Cameron Smail Library collection

Lothian health services archive finding aids
[Lothian health services archive finding aids](#)
Use to search for items belonging to the following selected collections:
Lothian health services archive

Napier University information network
[Napier University Information Network](#)
Use to search for items belonging to the following selected collections:
Napier University Canaan Lane Learning Centre collection
Napier University Comely Bank Library collection
Napier University Craighouse Learning Centre collection
Napier University Merchiston Library collection

National Library of Scotland general collections catalogue
[National Library of Scotland WebPAC](#)
Use to search for items belonging to the following selected collections:
National Library of Scotland Map Library collection
National Library of Scotland collection (main)

Queen Margaret University College library catalogue
[Queen Margaret University College WebPAC](#)
Use to search for items belonging to the following selected collections:
Queen Margaret University College Corstorphine Campus Library collection
Queen Margaret University College Leith Campus Library collection

SCAN online catalogue
[SCAN online catalogue](#)
Use to search for items belonging to the following selected collections:
Heriot-Watt University Archive, Records Management and Museum Service collection
Royal Bank of Scotland Archives collection

Scottish Poetry Library catalogue
[Scottish Poetry Library WebPAC](#)
Use to search for items belonging to the following selected collections:
Scottish Poetry Library collection

There are no online catalogues for the other collections in the selection.

 Click the Collection Descriptions button to display more information about the listed collections.

Screen 19: Finding aids for the landscape of collections located in Edinburgh: second half of list (partial screen).

Relating SCONE/CAIRNS to other landscapes

Portlet canned searches on CAIRNS miniclumps can be used as components of other landscapes. For example, the subject keyword input by a user in a remote clump can be fed into the open URL for CAIRNS miniclump 10 described in the section on Portlet canned searches in this report. It is possible to use this technique on all of the CAIRNS search indexes.

A similar facility for specifying canned searches in SCONE has also been developed as part of the SPEIR project. This allows a URL to carry the search parameters for finding CLDs; that is, the URL invokes a SCONE collection landscape.

Screen 3 shows the use of CAIRNS and SCONE as part of the landscape of the Distributed National Burns Collection. The CAIRNS canned search uses a miniclump of catalogues with a significant number of records returned for a search for the author Robert Burns. The SCONE canned search uses a canned search for the landscape **Agent is Robert Burns**.

Work Package B also investigated the implications concerning a collection of interest to SCONE that was already part of another information environment which did not overlap with SCONE. Local collection descriptions published online by members of the RIDING and InforM25 clumps were browsed to identify any about Scottish topics; by definition, neither of these environments contain collections located in Scotland. Only one such collection was identified, the MacColl and Seeger collection held in Goldsmiths College Library, a member of InforM25. There are two likely explanations for this result:

- There are more collections on Scottish topics in the Yorkshire and London areas, but they have yet to be described online.
- Collections on well-defined regional topics tend to be accumulated, acquired, and held inside that region.

A SCONE CLD for the MacColl and Seeger collection was created. This is shown in Screen 20.

[Home](#)

MacColl and Seeger collection

[Help](#)

[Online Catalogues](#)

[Super Collections](#)

Description	The library of the folk-singers Ewan MacColl and Peggy Seeger, two key members of the Folk Music revival, which began in the 1950s. The collection covers British and Irish folk-song and ballads, but is particularly strong on Scotland.
Type	Collection.Library.Text.Special
Location	Goldsmiths College Library New Cross London (City of London, England) SE14 6NW
Collectors	Ewan MacColl [Accrual: policy is Closed; periodicity is Closed; method is Purchase] Peggy Seeger (1935-) [Accrual: policy is Closed; periodicity is Closed; method is Purchase]
Subjects	Folk songs, English Folk songs, Irish Folk songs, Scots Folk songs, Scottish Gaelic
Part of	Goldsmiths College Library collection
Catalogues	Goldsmiths College Library catalogue

Screen 20: Collection-level description of the MacColl and Seeger collection (partial screen).

CLDs for the rest of the collection hierarchy were also created; that is Goldsmiths College Library collection and catalogue, the functional granularity collection of items described in the InforM25 clump, and the clump catalogue (Z client). This is the same approach taken with the COPAC collections and catalogues.

Diagram 3 shows the resulting collection hierarchy.

As usual, the SCONE CLD only discloses the finding aid at the lowest level of aggregation. In this instance, the Goldsmiths College Library (GCL) catalogue is displayed, but not the higher level InforM25 clump catalogue. If the GCL catalogue was to be removed from SCONE, Screen 20 would show a link to the InforM25 clump instead.

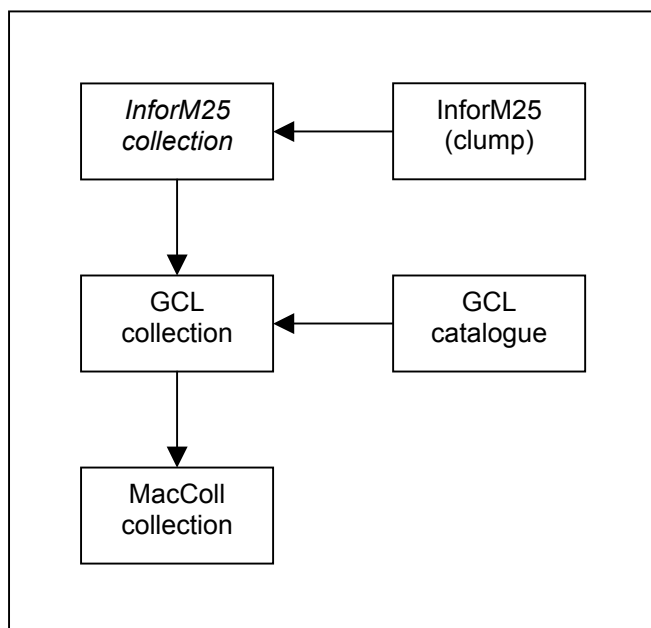

Diagram 3: InforM25 collection hierarchy and inheritance.

There are some differences between this scenario and the relationship between SCONE and COPAC.

With COPAC, SCONE is dealing with overlapping organizational collections. Organizational collections are at the top of physical collection hierarchy; although they may be part of distributed super-collections, they are not part of any other physical super-collection.

COPAC only requires high-level CLDs to landscape its service. There is no need for named sub-collections to be described as there is no way of isolating their items with COPAC; there is no need for system-defined sub-collections, say to indicate strengths in a specific subject or language, because the service provides item-level metadata to create such sub-sets dynamically.

COPAC and SCONE overlap, therefore, only at the highest levels of the collection hierarchy. A service like SCONE already has all of the lower-level detail, including the availability of local, more co-extensive finding aids, and including a physical union catalogue like COPAC is primarily a matter of creating a small number of CLDs using functional granularity to join the levels. COPAC does not require, nor is likely to create, CLDs for description at a lower level of granularity, so SCONE is not duplicating anything unnecessarily.

With the MacColl and Seeger collection, the overlap between SCONE and InforM25 is at a much lower level of CLD. In the absence of mechanisms for interoperating CLDs in different services, SCONE is obliged to create CLDs for the rest of the collection hierarchy upwards, to the top level. While this is not an issue for isolated cases, it has implications for distributed collection landscaping services in a wider sense.

Ideally, local collection services should create and maintain CLDs at a level of granularity that encourages use by external landscaping services. This implies that services should develop interfaces that:

- Offer standard mappings via machine-to-machine to generate the collection landscapes useful to the remote service.
- Allow a local CLD at any level of granularity to be displayed by the remote service.
- Make available to the remote service the full local functionality of super-collections and online finding-aids related to the local CLD.

While it might be necessary to duplicate part of the CLD on the remote service, for example a universal identifier and title, services should not have to duplicate higher-level aggregations.

Such functionality is still required even if local services offer completely interoperable dynamic landscaping facilities; remote services will still need to create the equivalent of static landscapes, which cannot be assembled from local finding and mapping facilities and must be defined explicitly.

Implications for UKNUC

CC-interop Work Package A has shown that it is technically possible to create effective distributed union catalogues that can interact with physical union catalogues. Each type of union catalogue can be treated as a single member of a larger, necessarily distributed union catalogue. This model can be extended to harvested union catalogues, which duplicate item-level metadata like a physical union catalogue but may require more flexible and extensive collection-level metadata for effective landscaping.

A possible model for a UK National Union Catalogue (UKNUC) is such a distributed union catalogue of hybrid union catalogues. The overall UKNUC would be a distributed union catalogue interoperating using Z39.50 and similar cross-walking technologies. Each component of this UKNUC is itself a union catalogue, but can be any of the three types:

- Physical union catalogue.
- Distributed union catalogue.
- Harvested union catalogue.

While it would be feasible to mandate in which union catalogue (and type) a specific item or collections of items should be recorded, this would probably conflict with local arrangements involving other high-level aggregations of finding aids created for different purposes. It is more likely that a distributed UKNUC will be built up from the bottom as well as down from the top.

This has implications for collection landscaping in UKNUC. A top-down approach would not need a sophisticated landscaping service because the relationships between item, collection, and catalogue would be straightforward, and it would be relatively easy to minimise duplication of item metadata between multiple catalogues.

A bottom-up approach would have to cater for the situation where metadata for a single item is published in a local online catalogue that has a separate Z39.50 server. The server itself could belong to more than one clump, so that a specific metadata record would become accessible via the local catalogue and every clump that includes the server.

At the same time, the metadata might be copied, and possibly transformed during the process, to a physical union catalogue. The metadata might also be transformed and placed in an OAI metadata repository, from which it may be subsequently copied for an unknown number of harvested union catalogues.

Diagram 4 indicates the resulting complexity. The same item may appear multiple times in the high-level union catalogue, as well as in multiple landscapes associated with the union catalogue.

CC-interop Work Package B has shown that collection landscaping is a useful tool to improve the usability of such complex information environments.

The collection-level descriptions used in a landscaping service need to be able to accommodate the range of landscape mapping attributes, or options for finding collections with common characteristics, currently supported by SCONE and similar services, including collection title, location, language, education level, and associated agent, to ensure the needs of a wide range of users are catered for.

CLDs need to be created at several levels of granularity to allow precision in creating and refining landscapes.

Functional granularity is a useful approach because it allows services to create CLDs at appropriate levels of granularity for improving service functionality. It also improves the coherency of landscapes involving multiple finding aids at varying levels of aggregation.

The SCONE approach of only disclosing finding aids at the lowest level of aggregation, or most co-extensive with the level of collection hierarchy of interest, can simplify the landscape for the user while allowing the disclosure of broader finding aids as the user traverses the hierarchy.

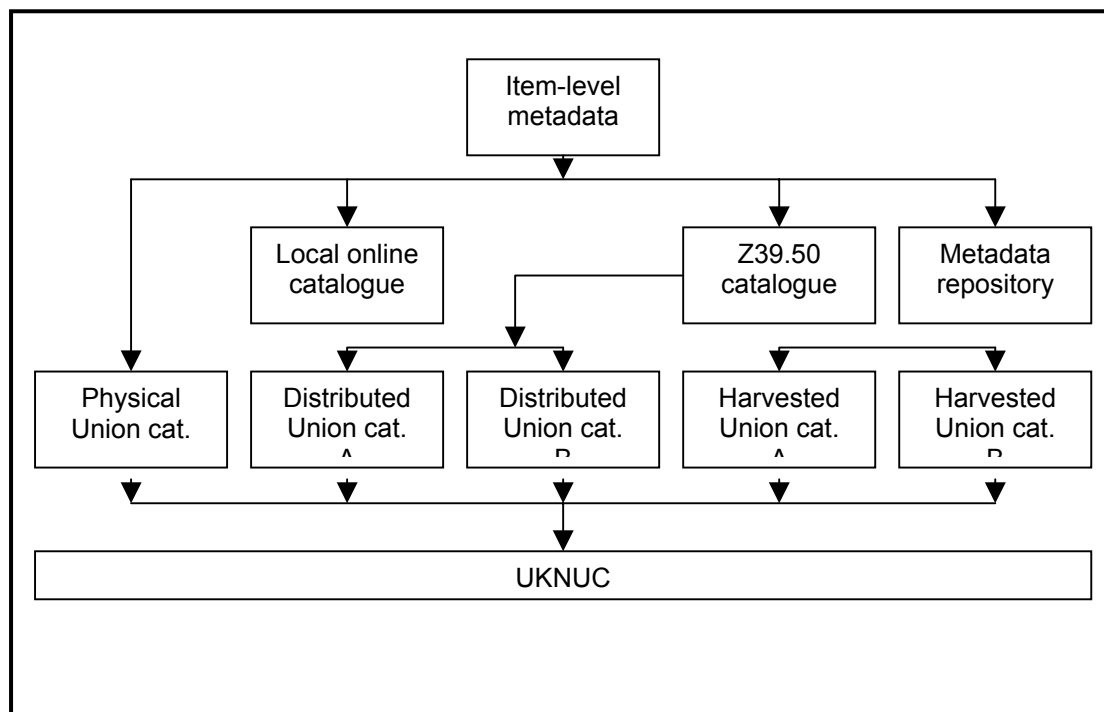

Diagram 4: UKNUC as a hybrid, distributed union catalogue.

This implies that an efficient and effective landscaping service for UKNUC would benefit from co-ordination of CLD creation by UK service providers to ensure interoperability at higher levels of aggregation. This should involve the development of a protocol covering:

- Creation and disclosure of unique identifiers for CLDs.
- Guidance on creating CLDs based on functional granularity requirements.
- Disclosure of local CLD hierarchies to external services.
- Recommended minimum set of finding options for landscape mapping by UKNUC users.
- Guidelines on interoperable content for mapping options, such as subject topic, form of agent name, and geographical location.

SCONE offers some powerful reasons for suggesting that a distributed UKNUC should be planned on a regional basis, with the development of information environments based on distinct geographical areas collectively covering the whole of the UK:

- A number of regional information environments, including SCONE and CAIRNS, are at a relatively advanced stage of development.
- Data for the basis of regional CLD services are available in the form of institutional and service directories that are often geographically based.
- The physical location of non-digital collections is an important factor for users creating dynamic landscapes.
- Users do not make distinctions about how a collection is managed or its finding aid constructed. There is demand for services which cover archives, libraries, museums, and digital collections in an integrated way, as illustrated by the Exploring Scottish history directory.

- There is a likelihood of overlap in regional cross-domain CLD services of personal and organizational agents as owners, collectors, and subjects. Local authorities have ownership of collections in public archives, libraries, and museums. Collectors often split and donate hybrid collections to local cultural institutions. Local people, companies, societies, and agencies will be the subject of archives, manuscripts, memorabilia, ephemera, and books.
- Local information professionals are better-placed to create and maintain controlled vocabularies for local agents and collection subjects, and often have existing networks and mechanisms for co-ordinating such activity.
- Collections with subjects of regional interest tend to be located within the region, and will be catered for by local CLDs. Where collections are located outside of the region, their remote CLDs may not exist or be accessible via the local subject because the remote service has no functional reason for doing so. A local CLD would probably have to be created anyway.

In Scotland there are many cross-sectoral and cross-domain information environments covering smaller geographic areas. Some examples are:

- Ayrshire Libraries Forum
- Edinburgh Libraries and Information Services Association
- Grampian Information
- Tayside and Fife Library and Information Network

These range in size from less than 10 institutional collections to well over 100. Rather than create Information Environments for themselves, they are all able to use SCONE and CAIRNS landscapes and miniclumps that reflect their local focus.

Conclusion

Collection-level description has a role to play in all stages of the Information Environment:

- The Entry stage can be a set of all CLDs in a service, or some pre-selected sub-set.
- The Survey stage involves refining the set presented in the Entry stage, by finding CLDs with related characteristics.
- The Discovery stage can use hyperlinks to online finding aids from individual CLDs. The set of CLDs selected in the Survey stage can be used to create miniclumps in distributed union catalogues.
- The Detail stage can use collection location and agent information to determine general collection availability.

Collection landscaping services can offer a number of Entry stage modes:

- The set of all collections in the environment. An example is the CAIRNS simple search.
- A static sub-set of collections designed for frequent use. An example is the CAIRNS miniclump and SCONE static landscape.
- Facilities for dynamic creation of sub-sets by searching for common attributes. An example is the SCONE landscaping tool.
- Facilities for manual creation of sub-sets by selection of individual collections. An example is the CAIRNS advanced search.

Automatic invocation by remote landscaping services of any of these Entry stage modes is desirable. SCONE has been used in this way by several external services:

- A distributed, hybrid collection with a specific focus. An example for the Distributed National Burns Collection is shown in Screen 3.
- An exhibition with a Scottish theme. An example is a SCONE portlet landscape for **Agent is William Speirs Bruce** created for the centenary of the Scottish National Antarctic Expedition of 1903-4, of which Bruce was the leader.
- The Scottish cultural portal uses dynamic subject- and agent-based SCONE landscapes.

A single CLD can be used as the basis of the Survey stage by finding collections with the same location or associated agent.

The principle of functional granularity can be used to create structured collection hierarchies for linking CLDs with collections of metadata aggregated at a higher level. System-defined CLDs at the same level of granularity as aggregated finding aids create a hierarchy of levels giving a measure of relative co-extensivity and precision, illustrated by Diagram 1, Diagram 2 and Diagram 3. This can be used to simplify the Discovery stage for the user interested in a specific collection by disclosing only the nearest or most co-extensive online catalogues, as shown in Screen 16.

The same hierarchies can be used when there are overlapping aggregations of metadata in a single distributed union catalogue or clump. If a lower-level Z target is temporarily unavailable, the hierarchy can be used to automatically disclose a higher-level target.

The Detail stage benefits from general information about access to collections, distributed in Heaney's model between attributes of location, owner, and administrator. Such information includes location opening hours, restrictions on access to specific types of collection, and license conditions. SCONE allows this type of information to be inherited from super-collections which are co-extensive with the location and administrator, using functional granularity to create system-defined CLDs where required. This avoids unnecessary duplication of data entry, storage, and maintenance.

The development of SCONE has shown that creating a comprehensive set of CLDs for institutional collections based on organization and agent directories as justification for functional granularity produces a service for supporting the Detail stage which is:

- Maintainable. The SCONE institutional CLDs for libraries are updated annually as a result of the production of SLIR.
- Able to display general access conditions for special and named sub-collections as soon as they are added to SCONE, automatically, through inheritance from the collection hierarchy.
- The basis of a geographical landscaping service from location addresses, using a controlled thesaurus of towns, regions, and countries.

References

- ¹ CC-interop project plan. Version 2. Available: <http://ccinterop.cdrl.strath.ac.uk/documents/cc-interop%20projplan%20issue2.pdf> (Last visited 3 April 2004)
- ² Grout, C. (2001). Information environment: development strategy 2001-2005, 2nd draft. London: JISC. Available: http://www.jisc.ac.uk/uploaded_documents/IE_Strategy.rtf (Last visited 9 June 2004)
- ³ Powell, A. & Lyon, L. (2003). JISC Information Environment Architecture: Functional Model. Bath, UKOLN. Available: <http://www.ukoln.ac.uk/distributed-systems/jisc-je/arch/functional-model/> (Last visited 9 June 2004)
- ⁴ CAIRNS service. (2002). CAIRNS. Glasgow, Centre for Digital Library Research. Available: <http://cairns.lib.strath.ac.uk/> (Last visited 9 June 2004)
- ⁵ SPEIR: Scottish Portals for Education, Information and Research. Available: <http://speir.cdrl.strath.ac.uk/> (Last visited 3 April 2004)
- ⁶ Scottish Confederation of University and Research Libraries. Available: <http://scurl.ac.uk/> (Last visited 7 June 2004)
- ⁷ Scotland's culture. Available: <http://www.scotlandsculture.org/> (Last visited 3 April 2004)
- ⁸ Gilby & Sanders (2003). Transforming a clump into a Z-target: a feasibility study. Available: http://ccinterop.cdrl.strath.ac.uk/documents/Clump_ztarget_issue1_0.pdf (Last visited 10 June 2004)
- ⁹ Distributed National Burns Collection. Available: http://www.scottishmuseums.org.uk/members_services/grants/SCF/SCF03.asp (Last visited 9 June 2004)
- ¹⁰ Heaney, M. (2000). An Analytic Model of Collections and their Catalogues. Bath, UKOLN. Available: <http://www.ukoln.ac.uk/metadata/rsip/model/amcc-v31.pdf> (Last visited 9 June 2004)
- ¹¹ SCONE service. (2003a). Scottish Collections Network (SCONE). Glasgow, Centre for Digital Library Research. Available: <http://scone.strath.ac.uk/service/index.cfm> (Last visited 9 June 2004)
- ¹² CILIPS. Available: <http://www.slainte.org.uk/cilips/index.htm> (Last visited 9 June 2004)
- ¹³ Scottish library and information resources / edited by Gordon Dunsire and Penny Robertson. – 15th ed. – Hamilton : CILIPS, 2003. – ISBN: 0954116038.
- ¹⁴ SLIC. Available: <http://www.slainte.org.uk/slic/index.htm> (Last visited 9 June 2004)
- ¹⁵ Museums. Available: <http://www.scottishmuseums.org.uk/museums/index.asp> (Last visited 7 June 2004)
- ¹⁶ The directory: contact information for Scottish archives and associations. Available: <http://www.scan.org.uk/directory/index.htm> (Last visited 7 June 2004)
- ¹⁷ Dunsire (2004). Collections and collaboration in the Scottish information environment. In: WIDWISAWN, v.2, no.1. Available: http://widwisawn.cdrl.strath.ac.uk/issues/issue1_2.html (Last visited 7 June 2004)
- ¹⁸ SWOP: Scottish Working Group on Official Publications. Available: <http://scurl.ac.uk/about/swop.html> (Last visited 7 June 2004)
- ¹⁹ Exploring Scottish history: with a directory of resource centres for Scottish local and national history in Scotland / edited by Michael Cox. – 2nd ed. – [Hamilton] : Scottish Library Association; Scottish Local History Forum; Scottish Records Association, 1999
- ²⁰ Dunsire, G. (2002a). Extending the SCONE Collection Descriptions Database for CC-interop: Report for Work Package B of the CC-interop JISC Project. Glasgow, Centre for Digital Library Research. Available: <http://ccinterop.cdrl.strath.ac.uk/Documents/PDF-WordDocs/ExtendSCONEReport.pdf> (Last visited 9 June 2004)
- ²¹ SCAMP: Scottish Collections Access Management Portal. Available: <http://scone.strath.ac.uk/scamp/index.html> (Last visited 10 June 2004)
- ²² Research Collections Online. Available: <http://scone.strath.ac.uk/rco/index.cfm> (Last visited 6 June 2004)
- ²³ Scottish Confederation of University and Research Libraries. Available: <http://scurl.ac.uk/> (Last visited 6 June 2004)
- ²⁴ SEED project. Available: <http://seed.cdrl.strath.ac.uk/> (Last visited 6 June 2004)

²⁵ Cousins and Sanders (2003). Establishment of an M25 Z39.50 target and testing using a COPAC interface. Available: <http://ccinterop.cdlr.strath.ac.uk/documents/wpa-4-report.pdf> (Last visited 10 June 2004)

²⁶ COPAC. Available: <http://www.copac.ac.uk/copac/> (Last visited 9 June 2004)

²⁷ CLDT enumerated list of collection types. (2000). Available: <http://www.ukoln.ac.uk/metadata/rslp/types/> (Last visited 9 June 2004)

²⁸ HaIRST project plan. Available: <http://hairst.cdlr.strath.ac.uk/documents/Hairst%20Project%20Plan.pdf> (Last visited 9 June 2004)